

aquatica®

Function, Form & Fashion

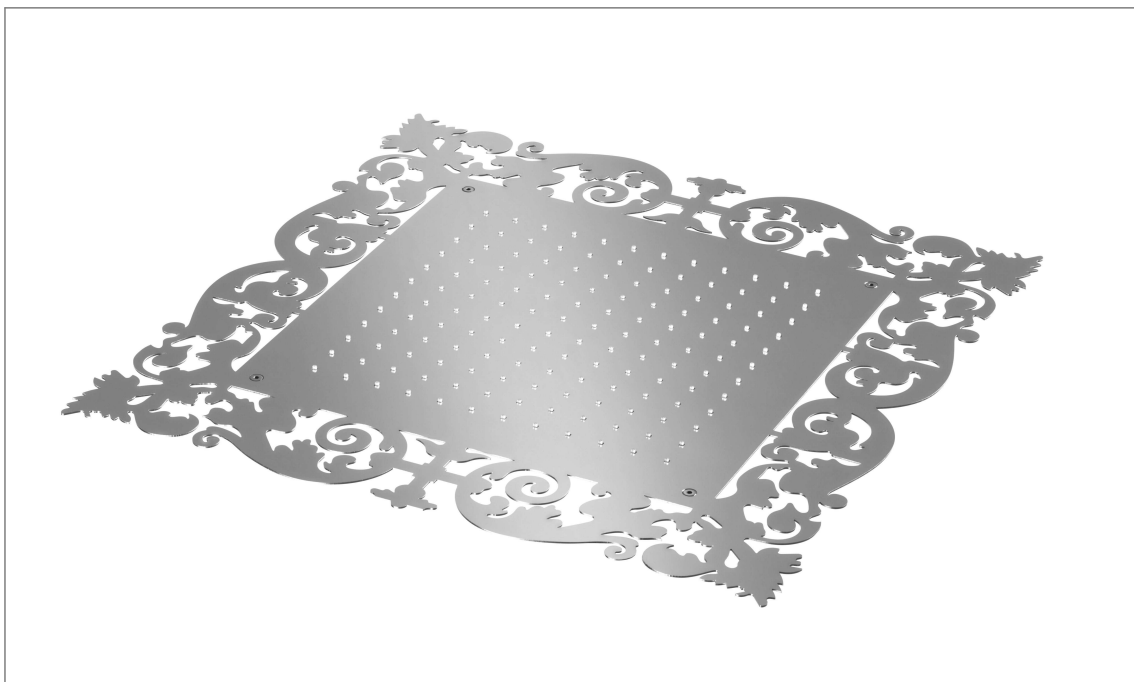

Ajour MCSQ-710/690

Built-In Shower Head

Installation & Care Manual
Europe/International

Ajour MCSQ-710/690

Built-In Shower Head

PARTS LIST / RAIN FLOW SPECIFICATION

TWO PEOPLE
REQUIRED FOR
INSTALLATION

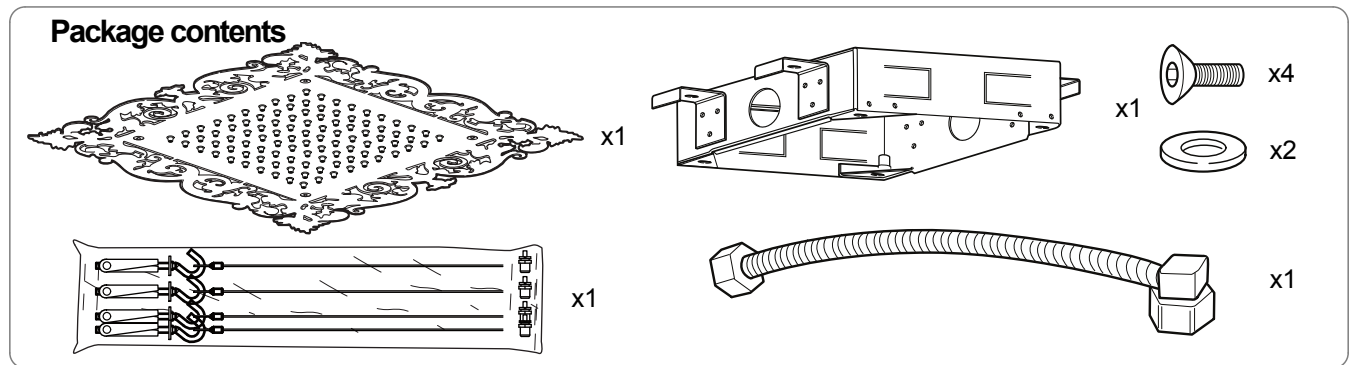
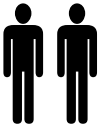

MEASUREMENTS: mm

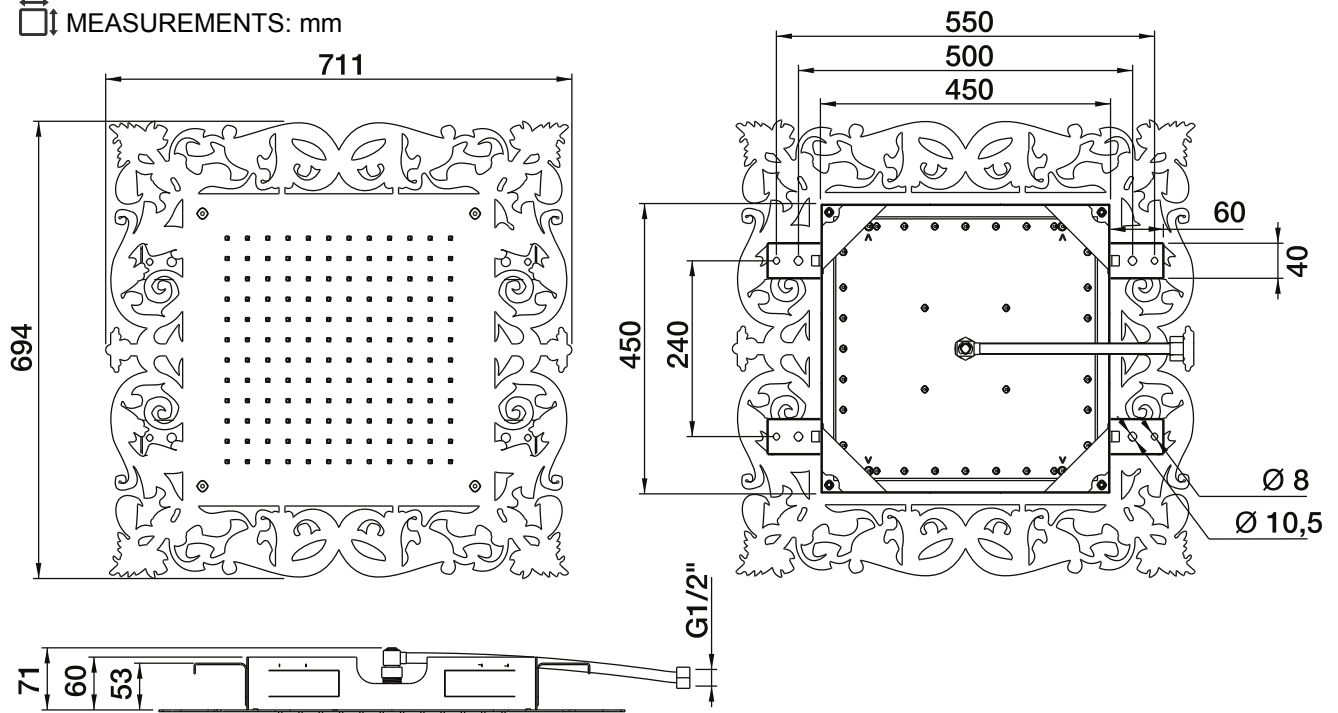

Rain flow l/min

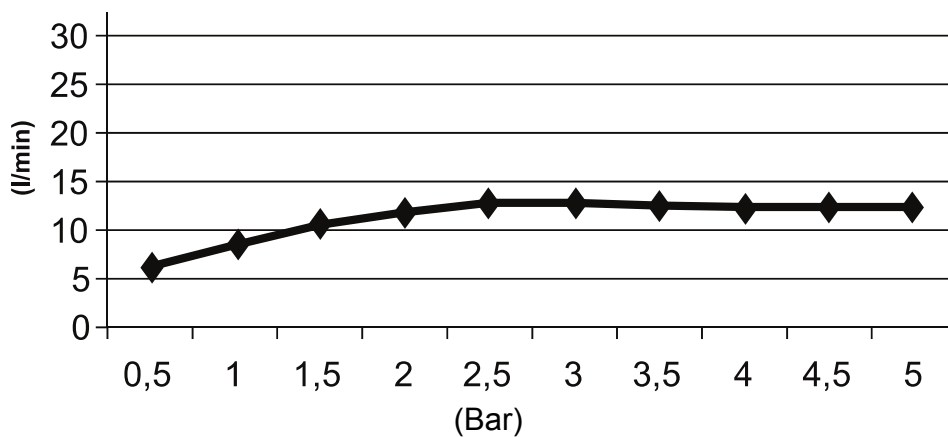

	MIN	1 Bar
	MAX	5 Bar
	BEST	3 Bar
	MAX	70° C
	BEST	38°/40° C

Ajour MCSQ-710/690

Built-In Shower Head

INSTALLATION SEQUENCE

aquatica®

Function, Form & Fashion

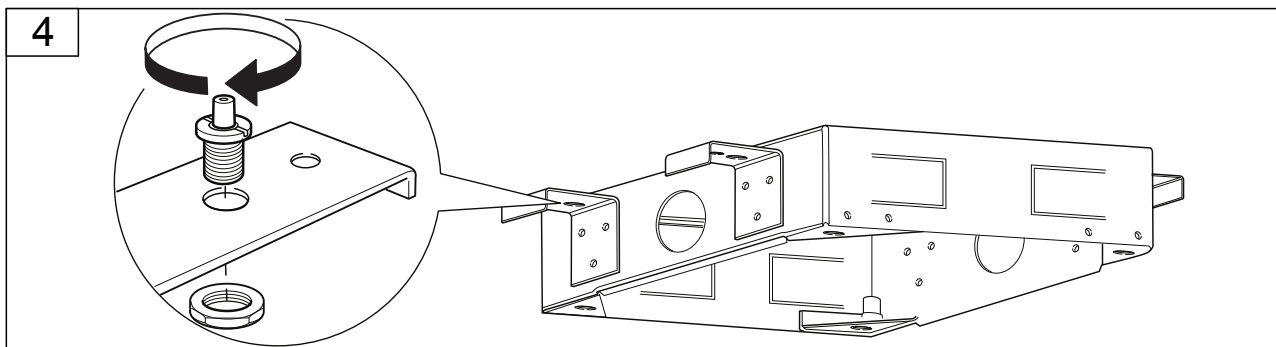
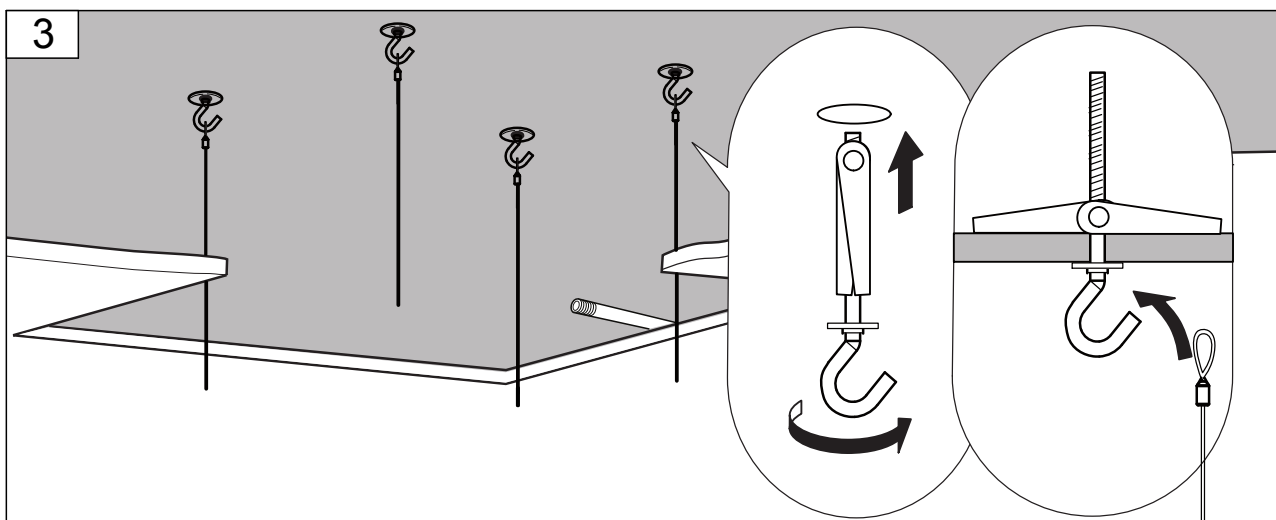
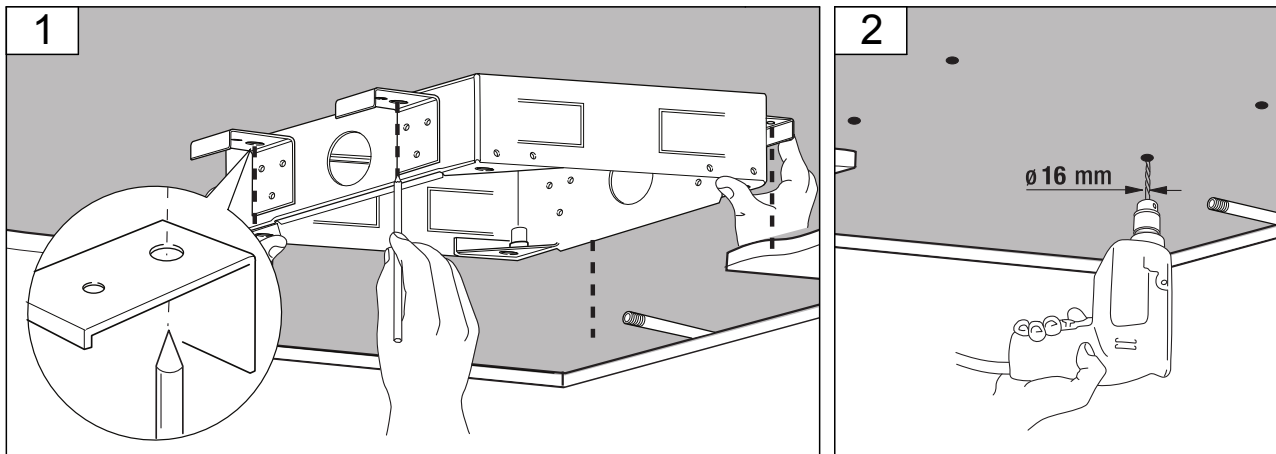
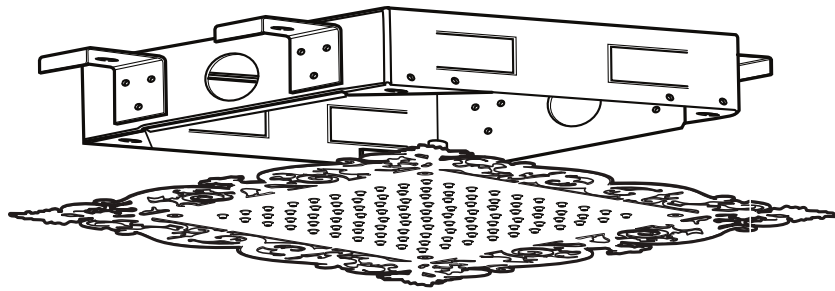

Ajour MCSQ-710/690

Built-In Shower Head

INSTALLATION SEQUENCE continued

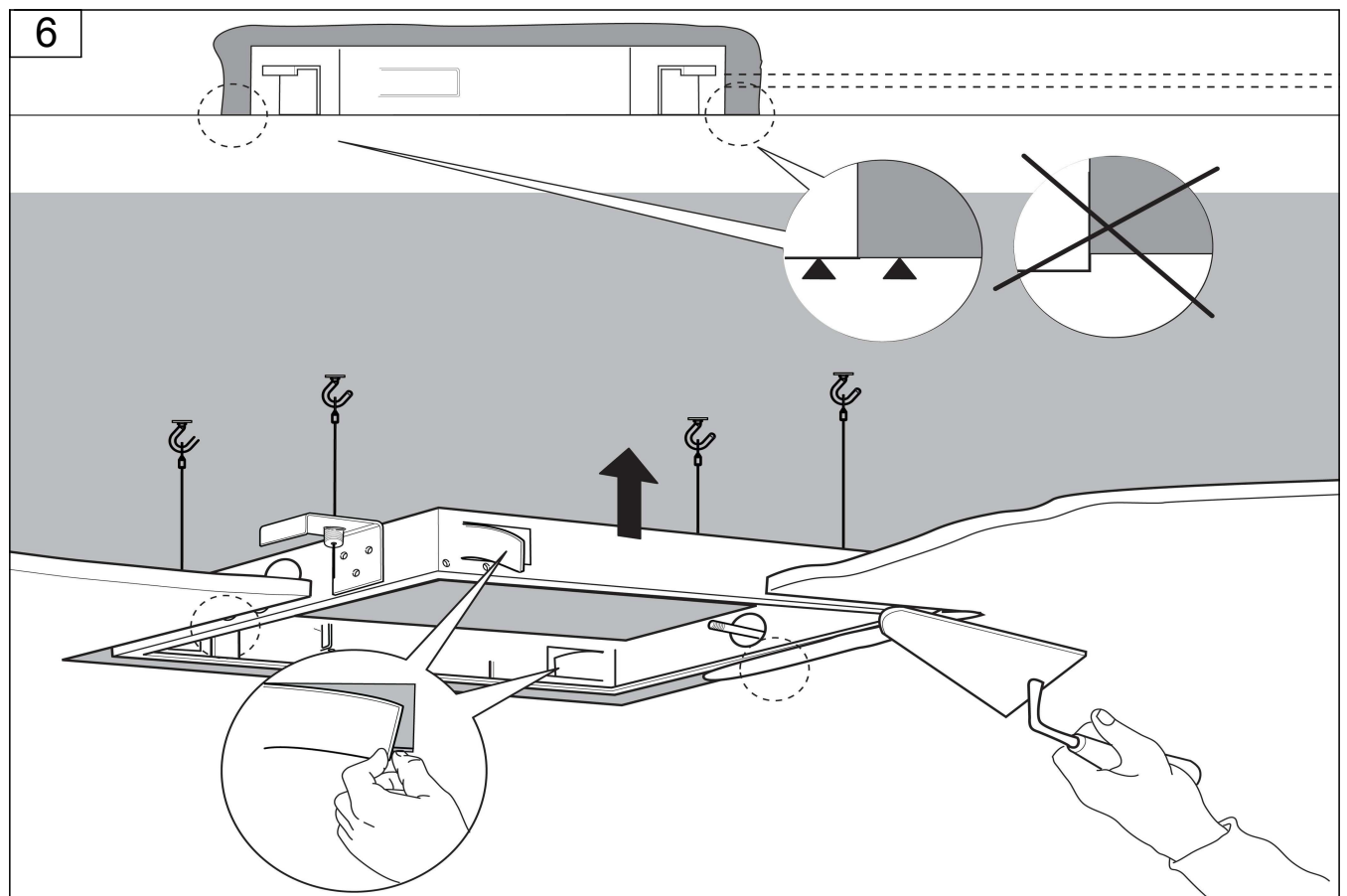
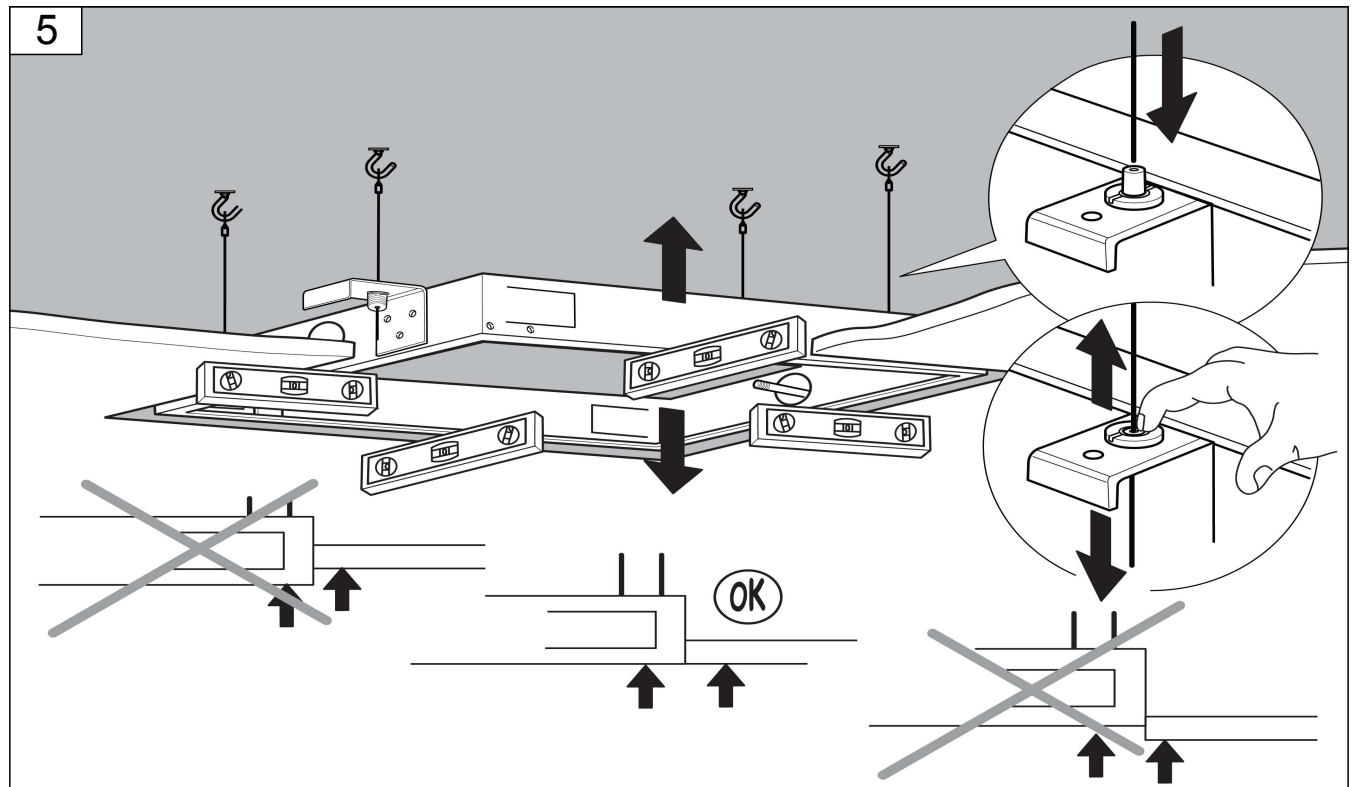

Ajour MCSQ-710/690

Built-In Shower Head

INSTALLATION SEQUENCE continued

aquatica®

Function, Form & Fashion

7

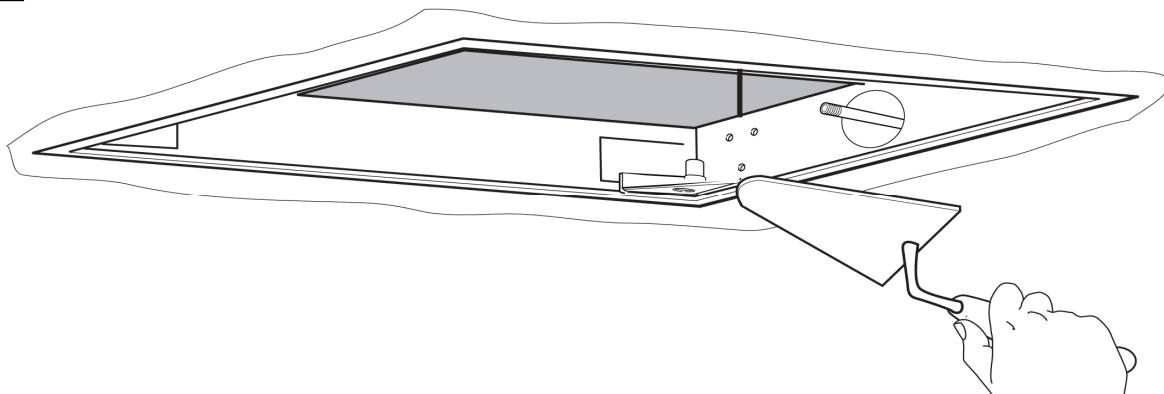

8

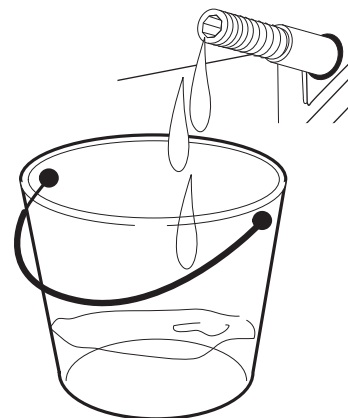
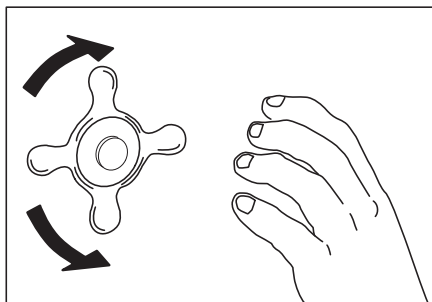

9

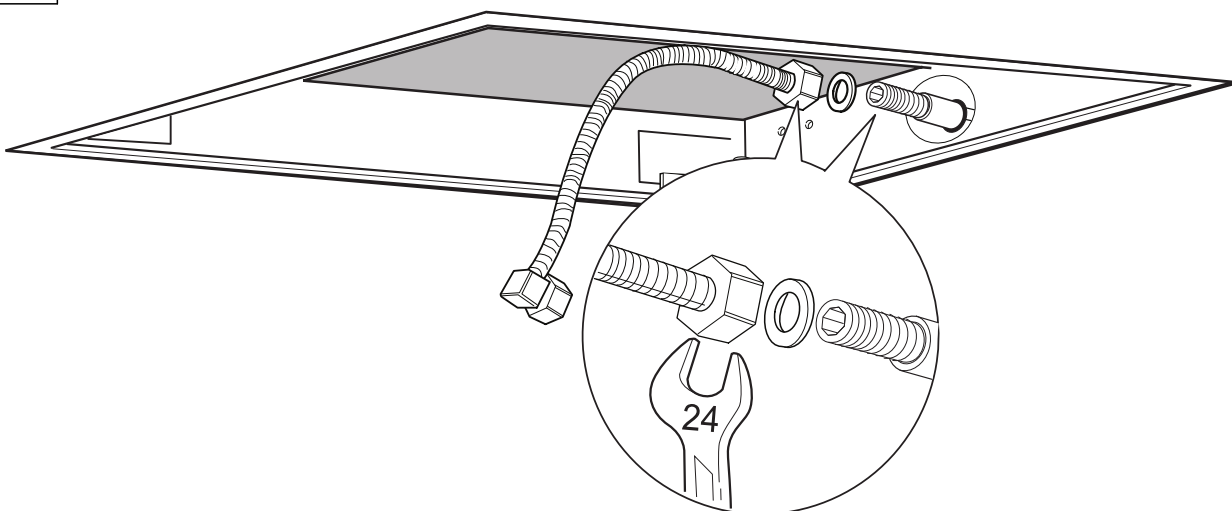

Ajour MCSQ-710/690

Built-In Shower Head

INSTALLATION SEQUENCE continued

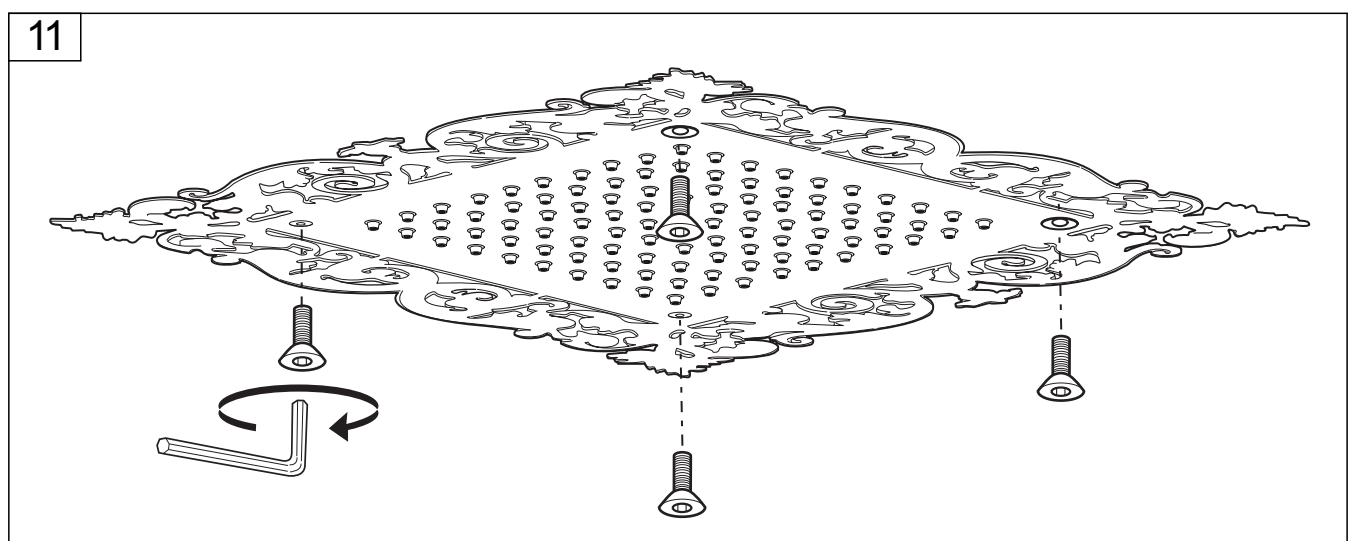
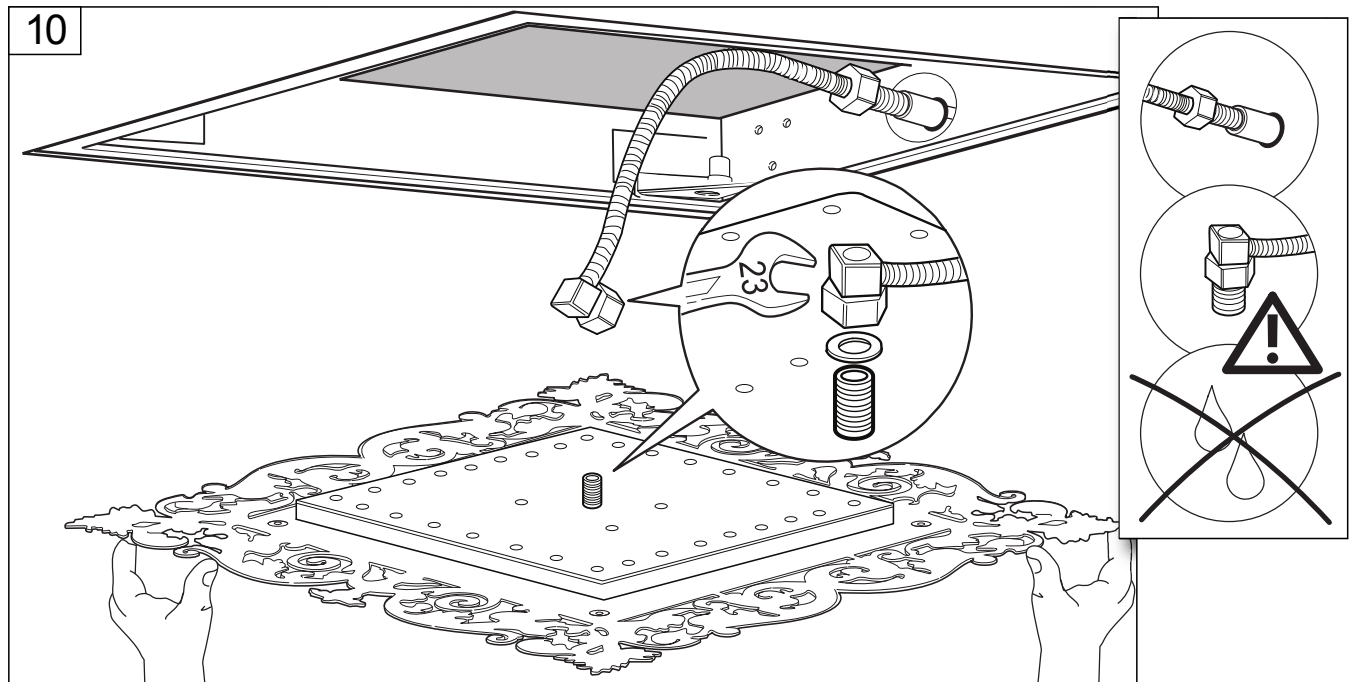

Ajour MCSQ-710/690

Built-In Shower Head

CLEANING TIPS

aquatica®

Function, Form & Fashion

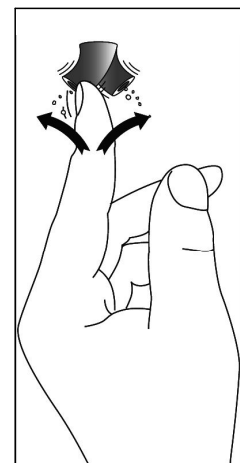
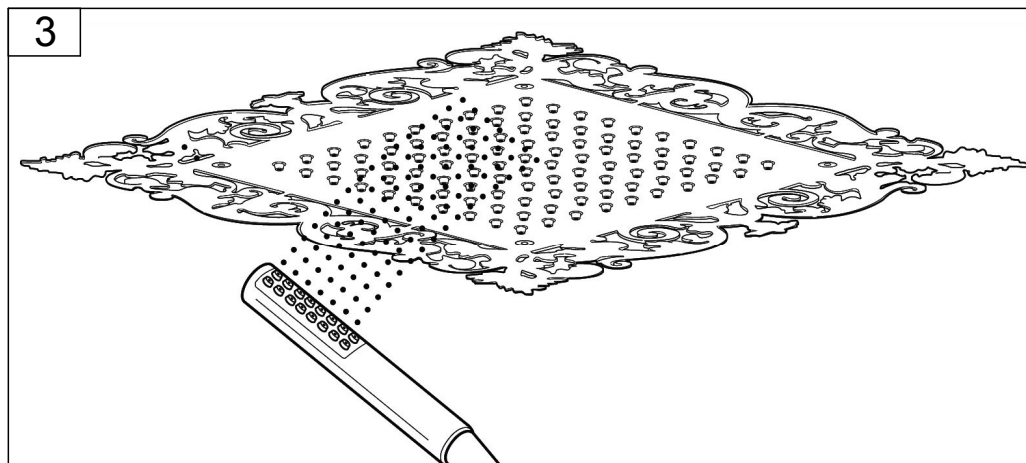
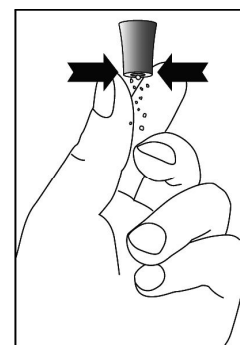
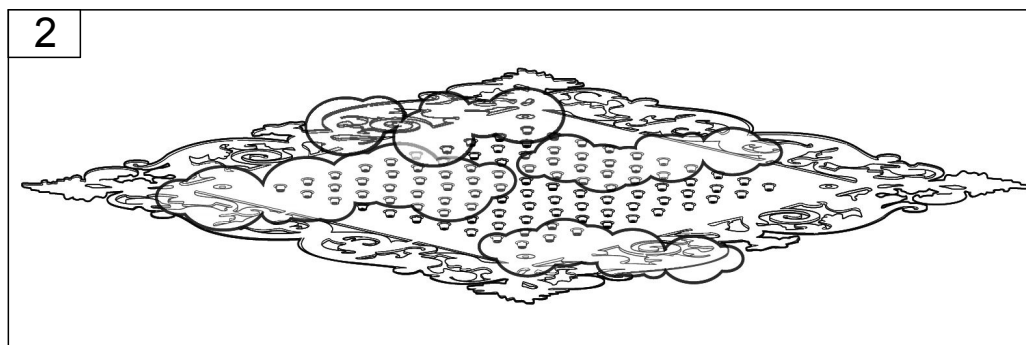
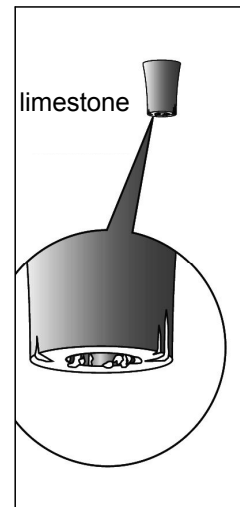
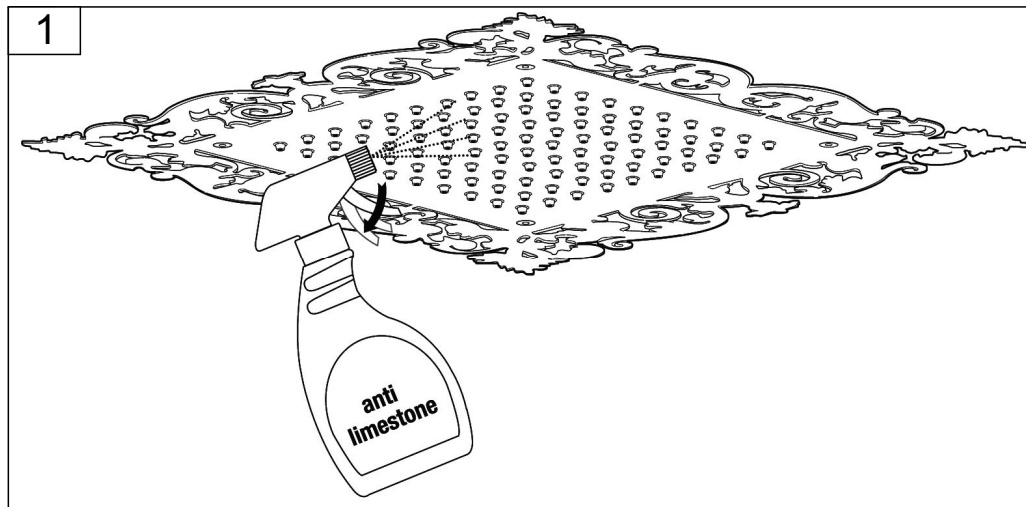

Cleaning of metal parts: For an easy cleaning of the metal parts of the product, simply use a soft cloth moistened in water and soap or an anti-limestone detergent. To avoid spots caused by calcium in water, we advise drying with a cloth after each use.

Advice: please use only natural soap-based detergents avoiding those with alcohol, hydrochloric acid or phosphoric acid, bleach, chlorine etc. and those containing abra-sive powders.

aquatica®
Function, Form & Fashion

